

# Stratford Vinyl/PVC

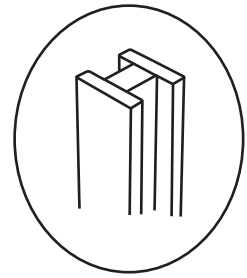

GREEN TEAK FENCES USE H-POSTS INSTEAD OF SQUARE POSTS

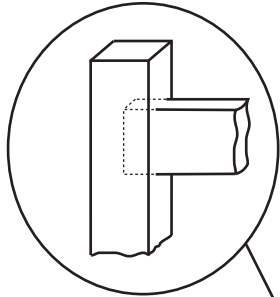

TOP VIEW (W/O LATTICE)

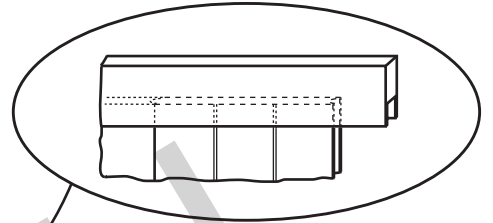
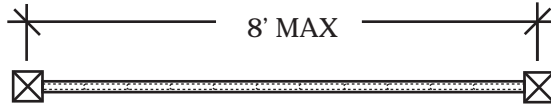

CHOICE OF TOPPER  
(SEE PAGE.3)

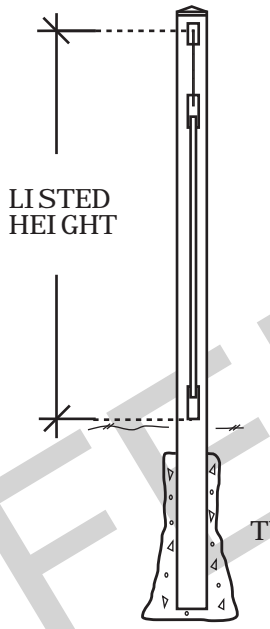

SIDE VIEW

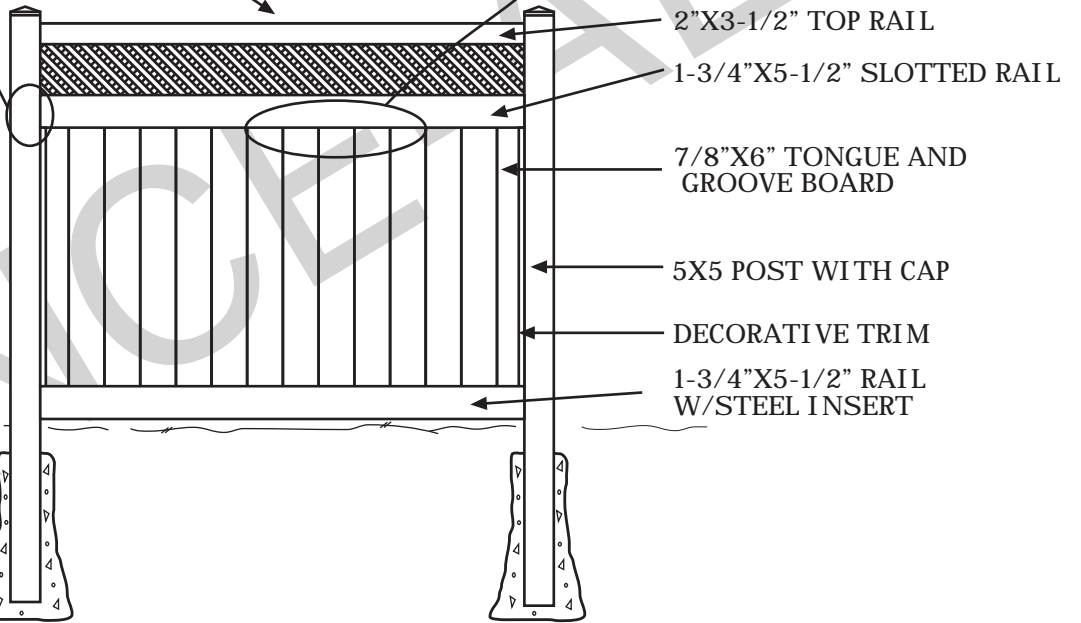

FRONT VIEW

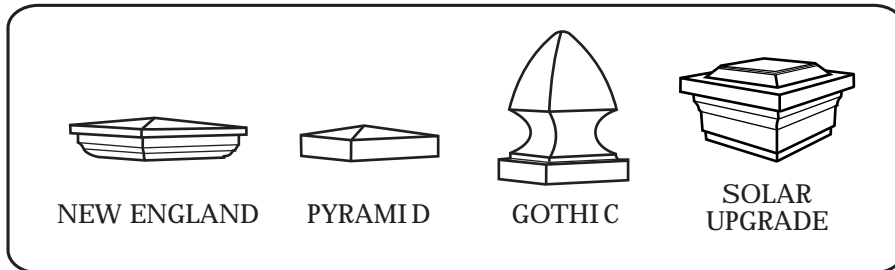

CHOICE OF CAP

**NOTES:**

- Green Teak jail bar/rails are substituted with Adobe.
- Chai Grey jail bar/rails/posts are substituted with White.
- Clearance below the fence isn't included in height calculations.
- We reserve the right to make changes or improvements to our designs without notice.

# Stratford Vinyl/PVC Gate

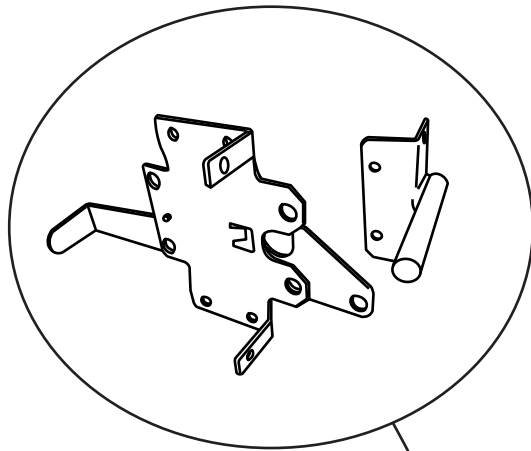

FINGER AND CATCH  
TYPICALLY INSTALLED  
@4'6"H MIN

TYPICALLY  
1" SPACE ON  
LATCH SIDE

TYPICALLY  
1/2" SPACE  
ON HINGE  
SIDE

OPTIONAL 2"X3-1/2" GATE  
BRACE TYPICALLY  
INSTALLED @7'H MIN

5X5 POST  
TYPICAL

TYPICALLY 1-1/2"  
SHORTER THAN  
MATCHING FENCE

2" to 4"

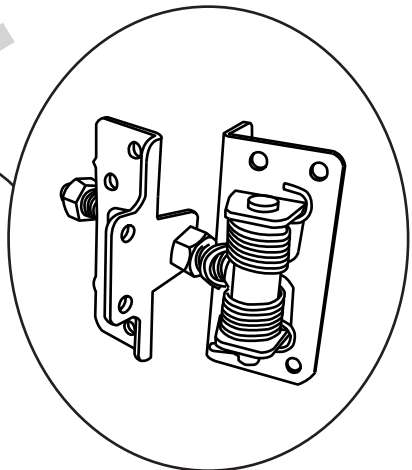

HINGES ADJUST TO  
SET GATE ALIGNMENT

## NOTES:

- Green Teak jail bar/rails are substituted with Adobe.
- Chai Grey jail bar/rails/posts are substituted with White.
- Clearance below the fence isn't included in height calculations.
- We reserve the right to make changes or improvements to our designs without notice.

# Topper Styles +

FILL MATCHES FENCE

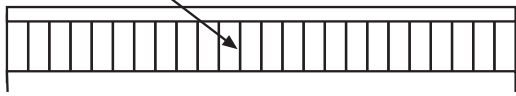

BOARD

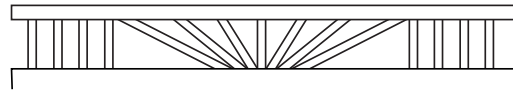

SUNBURST

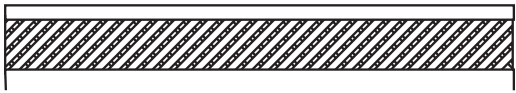

LATTICE

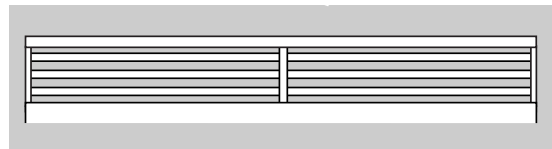

HORIZONTAL JAIL BAR

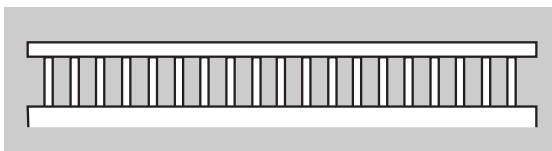

JAIL BAR

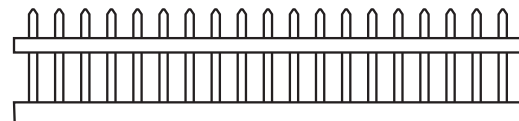

STRAIGHT PICKET

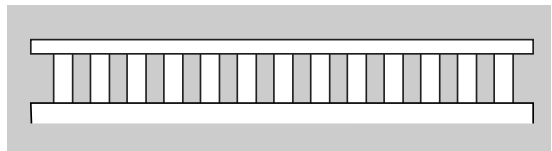

JAIL BAR THREE



STRAIGHT LIBERTY IRON

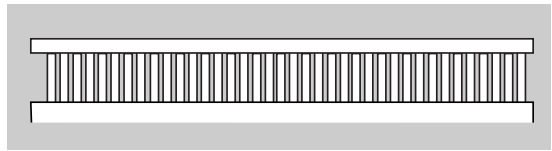

PRIVACY JAIL BAR

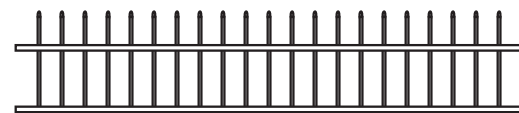

STRAIGHT MARQUEE IRON

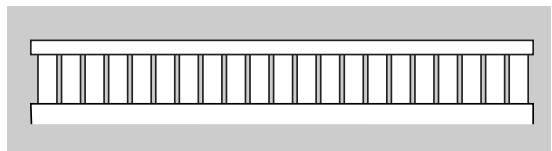

PRIVACY JAIL BAR THREE

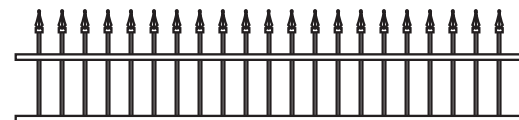

STRAIGHT ROCKEFELLER IRON

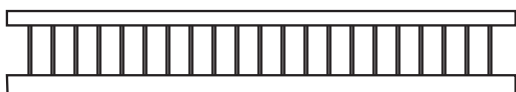

ROUND 3/4" METAL

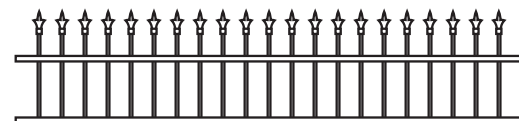

STRAIGHT EMPIRE IRON

NOTES:

- Prices vary depending on topper choice.