

Grand Parkdale Wood

TOP VIEW (W/O LATTICE)

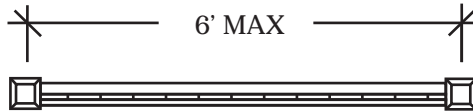

CHOICE OF 1' TOPPER
(SEE PAGE 3)

1X6 SCROLL CUT
FACEBOARD FRONT,
2X6 SCROLL CUT
FACEBOARD BACK

1X6 ABOARDS SPACED
UP TO 5/8" APART
ONCE WOOD DRIES
(STANDARD PATTERN
SHOWN)

4x4 POST WITH CAP

1" to 4"

2X4
TOP
CAP

1X4
SHELF

1X4 RAIL
FRONT, 2X4
RAIL BACK

3'
TYPICAL

LISTED
HEIGHT

SIDE VIEW

FRONT VIEW

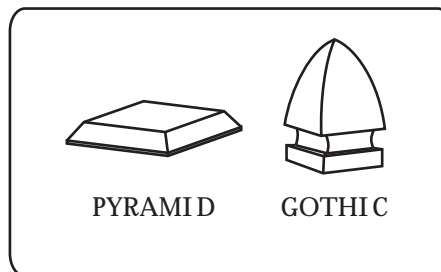

CHOICE OF CAP

NOTES:

- All dimensions are nominal.
- Clearance below the fence isn't included in height calculations.
- We reserve the right to make changes or improvements to our designs without notice.

Grand Parkdale Wood Gate

PADDLE LATCH DETAIL
(TYPICALLY INSTALLED AT
HEIGHT OF TOP RAIL)

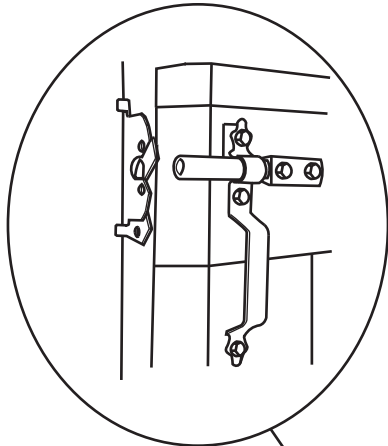

TYPICALLY
1-1/2" SPACE
ON LATCH
SIDE

TYPICALLY
1/2" SPACE
ON HINGE
SIDE

OPTIONAL 2X4 GATE
BRACE (TYPICALLY
INSTALLED AT 7'H)

GATE FRAME

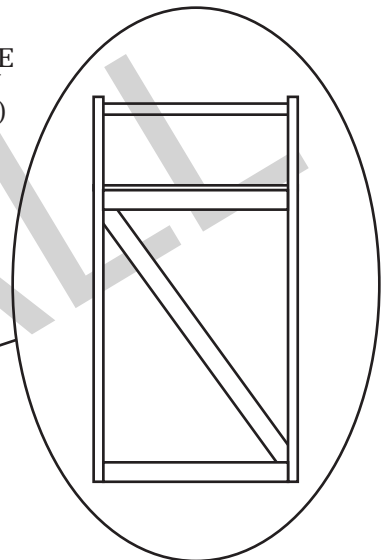

4X4 POST
TYPICAL

BRACE
ANGLES UP
TOWARDS
LATCH

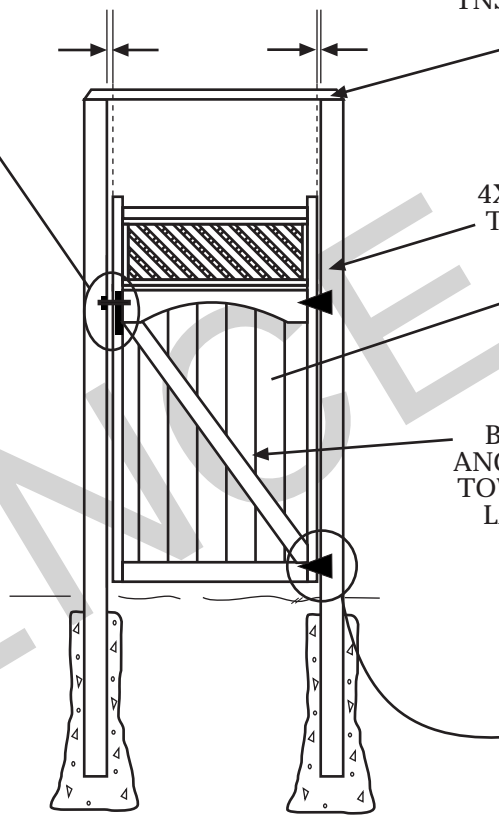

BACK VIEW

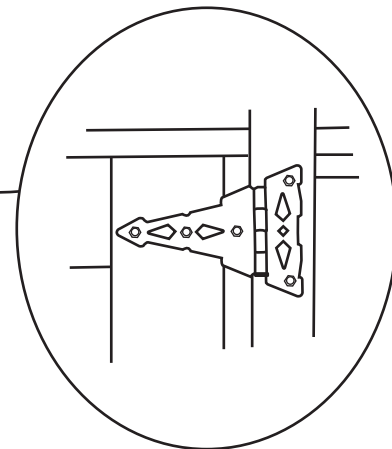

8" HINGE DETAIL

NOTES:

- All dimensions are nominal.
- Clearance below the fence isn't included in height calculations.
- We reserve the right to make changes or improvements to our designs without notice.

Topper Styles +

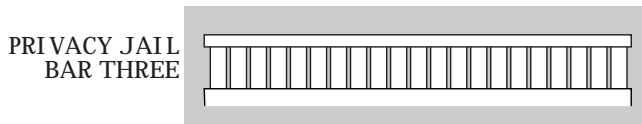
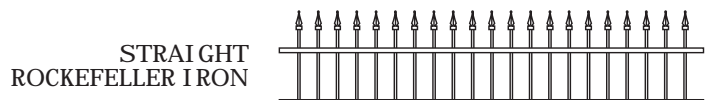
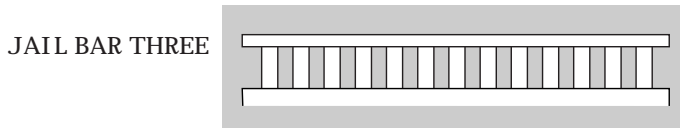
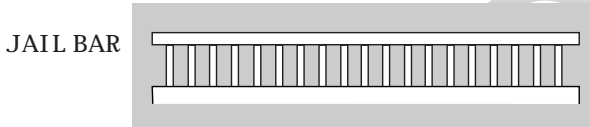
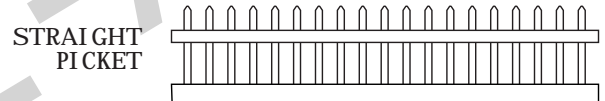
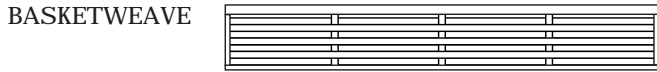
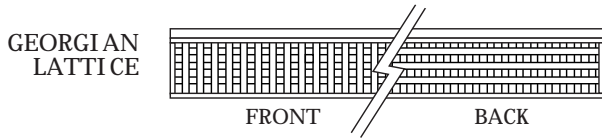
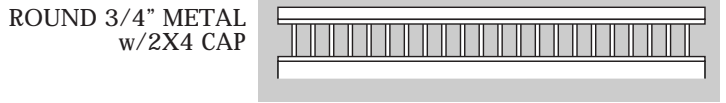
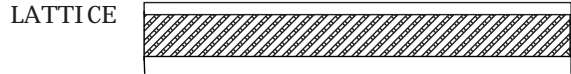
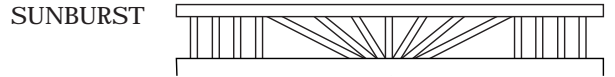
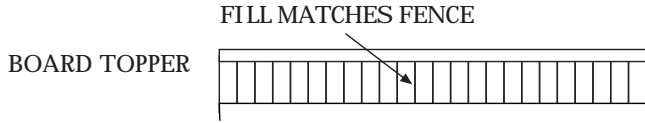

NOTES:

• Prices vary depending on topper choice.